

### FReta iEB Series DC/DC Power Modules 48V Input, 17A Output Eighth Brick

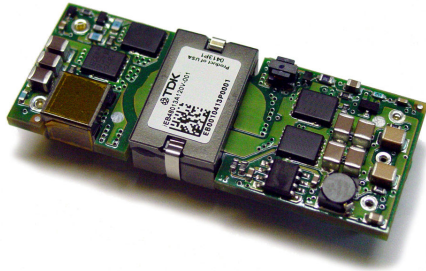

The FReta Series offers an **industry standard 150W Eighth brick** power module featuring a **high operating efficiency** that results in true useable power. The FReta modules offer a fixed conversion ratio of either 4:1 or 5:1.

#### Standard Features:

- Size – 58.4mm x 22.9 mm x 8.5 mm (2.30 in. x 0.90 in. x 0.34 in.)
- Thru-hole pins 3.68 mm (0.145")
- High efficiency – greater than 94%
- 2250Vdc isolation voltage
- Meets basic insulation spacing requirements
- Constant switching frequency
- Industry Standard Footprint
- Remote on/off (positive logic)
- Auto-recovering input over-voltage protection
- Auto-recovering output over-current protection
- Auto-recovering output short circuit protection
- Auto-recovering over-temperature protection

- Applying for UL 60950 (U.S. and Canada), VDE 0805, CB scheme (IEC950), CE Mark (EN60950)
- ISO Certified manufacturing facilities

#### Optional Features:

- Remote on/off (negative logic)
- Short Thru-hole pins 2.79 mm (0.110")
- Long Thru-hole pins 5.08 mm (0.200")
- Increased operating input voltage range



## Data Sheet: FReta iEB Series –Single Output Eighth Brick Bus Converter

### Ordering Information:

Product Identifier	Package Size	Platform	Input Voltage	Output Current/Power	Output Units	Main Output Voltage	# of Outputs	Safety Class	Feature Set
i	E	B	48	013	A	120	V	- 0	00
TDK Innoveta	Eighth-brick	FReta	48V - nominal	013 – 13.5A 017 – 17A	Amps	120 – 12V 096 – 9.6V	Single		00 – Standard



### Option Table:

Feature Set	Positive Logic On/Off	Negative Logic On/Off	0.110" Pin Length	0.200" Pin Length	0.145" Pin Length
00	X				X
01		X			X
04	X			X	
05		X		X	

### Product Offering:

Code	Input Voltage	Output Voltage	Output Current	Maximum Output Power	Efficiency
iEB48013A120V	42-56V	12V	13.5A	150W	94%



3320 Matrix Drive Suite 100  
Richardson, Texas 75082

Phone (877) 498-0099 Toll Free  
(469) 916-4747

Fax (877) 498-0143 Toll Free  
(214) 239-3101

[support@tdkinnoveta.com](mailto:support@tdkinnoveta.com)  
<http://www.tdkinnoveta.com/>

# Data Sheet: FReta iEB Series –Single Output Eighth Brick Bus Converter

## Mechanical Specification:

Dimensions are in mm [in]. Unless otherwise specified tolerances are:  $x.x \pm 0.5$  [0.02],  $x.xx$  and  $x.xxx \pm 0.25$  [0.010].

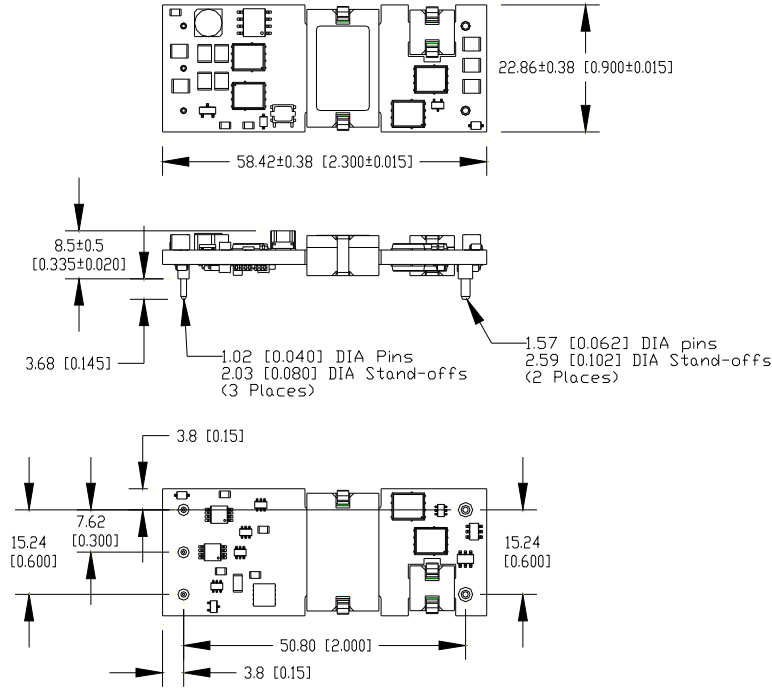

## Recommended Hole Pattern: (top view)

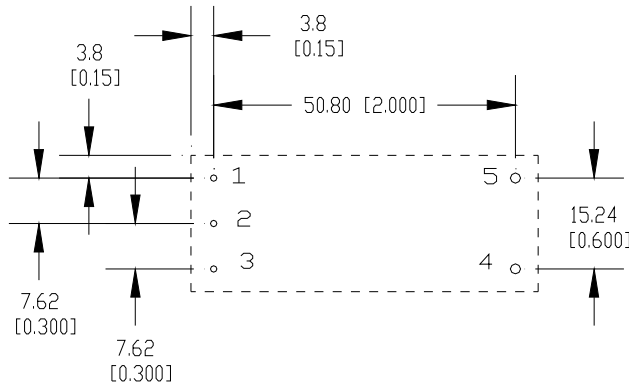

## Pin Assignment:

PIN	FUNCTION	PIN	FUNCTION
1	Vin(+)	4	Vo(-)
2	On/Off	5	Vo(+)
3	Vin(-)		

Pin base material is brass with plating; the maximum module weight is 27g (0.95 oz).

## Data Sheet: FReta iEB Series –Single Output Eighth Brick Bus Converter

### **Absolute Maximum Ratings:**

Stress in excess of Absolute Maximum Ratings may cause permanent damage to the device

Characteristic	Min	Max	Unit	Notes & Conditions
Continuous Input Voltage	-0.5	75	Vdc	
Transient Input Voltage	---	---	Vdc	
Isolation Voltage	---	2250	Vdc	Basic insulation
Storage Temperature	-55	125	°C	
Operating Temperature Range (Tc)	-40	120*	°C	Measured at the location specified in the thermal measurement figure. Maximum temperature varies with model number, output current, and module orientation – see curve in thermal performance section of the data sheet.

\*Engineering estimation

## Data Sheet: FReta iEB Series –Single Output Eighth Brick Bus Converter

iEB48013A120V-000 through -005: 12V, 13.5A Output

### Input Characteristics:

Unless otherwise specified, specifications apply over all Rated Input Voltage, Resistive Load, and Temperature conditions.

Characteristic	Min	Typ	Max	Unit	Notes & Conditions
Operating Input Voltage	42	48	56	Vdc	
Maximum Input Current	---	---	6*	A	Vin = 0 to Vin,max
Turn-on Voltage	---	39	---	Vdc	
Turn-off Voltage	35*	37	---	Vdc	
Hysteresis	0.5*	2	---	Vdc	
Startup Delay Time from application of input voltage	---	10	---	mS	Vo = 0 to 0.1*Vo,nom; on/off =on, lo=lo,max, Tc=25°C
Startup Delay Time from on/off	---	10	---	mS	Vo = 0 to 0.1*Vo,nom; Vin = Vi,nom, lo=lo,max,Tc=25°C
Output Voltage Rise Time	---	20	---	mS	lo=lo,max,Tc=25°C, Vo=0.1 to 0.9*Vo,nom
Input Over-voltage Turn-off	---	61	---	Vdc	Input rising
Input Over-voltage Turn-on	---	59	---	Vdc	Input falling
Input Over-voltage Hysteresis	---	2	---	Vdc	
Inrush Transient	---	---	0.2	A <sup>2</sup> s	
Input Reflected Ripple	---	50	---	mApp	See input/output ripple and noise measurements figure; BW = 20 MHz

\*Engineering estimation

Caution: The power modules are not internally fused. An external input line normal blow fuse with a maximum value of 10A is required; see the Safety Considerations section of the data sheet.

## Data Sheet: FReta iEB Series –Single Output Eighth Brick Bus Converter

iEB48013A120V-000 through -005: 12V, 13.5A Output

### Electrical Data:

Characteristic	Min	Typ	Max	Unit	Notes & Conditions	
Output Voltage Initial Setpoint	---	12	---	Vdc	Vin=Vin,nom; Io=no load(0A); Tc = 25°C	
Output Voltage Tolerance	8.9	12	14.4	Vdc	Over all rated input voltage, load, and temperature conditions to end of life	
Efficiency	---	94	---	%	Vin=Vin,nom; Io=Io,max; Tc = 25°C	
Line Regulation	---	3.5	---	V	Vin=Vin,min to Vin,max; Io=0A; Tc = 25°C	
Load Regulation	---	0.75	---	V	Io=Io,min to Io,max; Vin=Vin,nom; Tc = 25°C	
Temperature Regulation	---	60	---	mV	Tc=Tc,min to Tc,max; Io=Io,min	
Output Current	Vin=Vin,min	1*	---	15.5	A	At loads less than Io,min the module will operate correctly, but the output ripple may increase.
	Vin=Vin,nom			13.5		
	Vin=Vin,max			11.5		
Output Current Limiting Threshold	---	20	---	A	Vo = 0.9*Vo,nom, Tc<Tc,max	
Short Circuit Current	---	6	---	A	Vo = 0.25V, Tc = 25°C	
Output Ripple and Noise Voltage	---	50	200*	mVpp	Measured across one 0.1uF, and 2x22uF ceramic capacitors– see input/output ripple measurement figure; BW = 20MHz	
	---	15	---	mVrms		
Dynamic Response: Recovery Time	---	10	---	uS	di/dt = 1A/uS, Vin=Vin,nom; load step from 0% to 100% of Io,max	
Transient Voltage	---	400	---	mV		
Output Voltage Overshoot during startup	---	---	5	%	Vin=Vin,nom; Io=Io,max,Tc=25°C	
Output ripple Frequency	---	400	---	kHz	Fixed	
External Load Capacitance	0	---	4000&	uF		
Isolation Resistance	10	---	---	MΩ		

& Contact TDK Innoveta for applications that require additional capacitance or very low esr

\*Engineering estimation

# Data Sheet: FReta iEB Series –Single Output Eighth Brick Bus Converter

## Electrical Characteristics:

iEB48013A120V-000 through -005: 12V, 13.5A Output

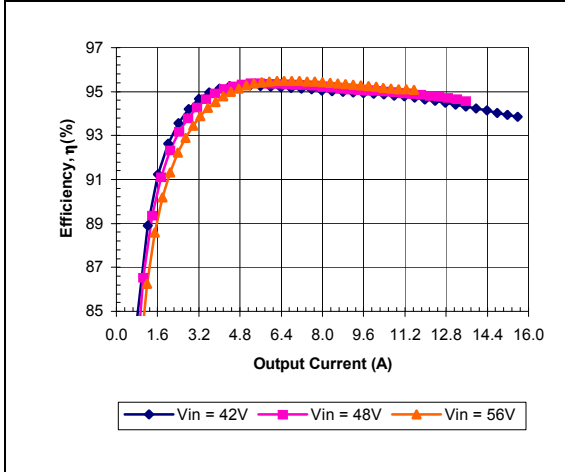

iEB48013A120V-000 Typical Efficiency vs. Input Voltage at Ta=25 degrees.

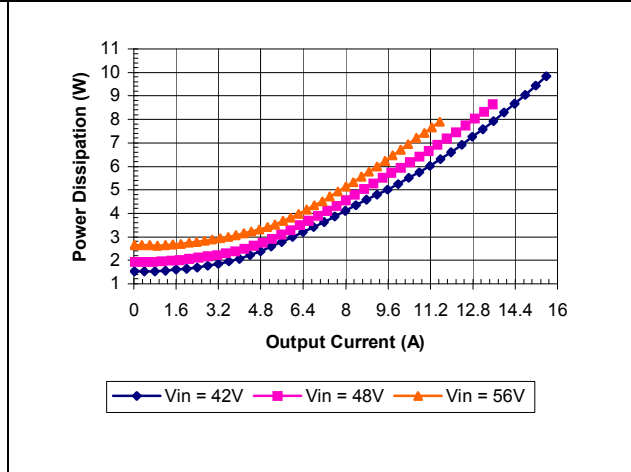

iEB48013A120V-000 Typical Power Dissipation vs. Input Voltage at Ta=25 degrees

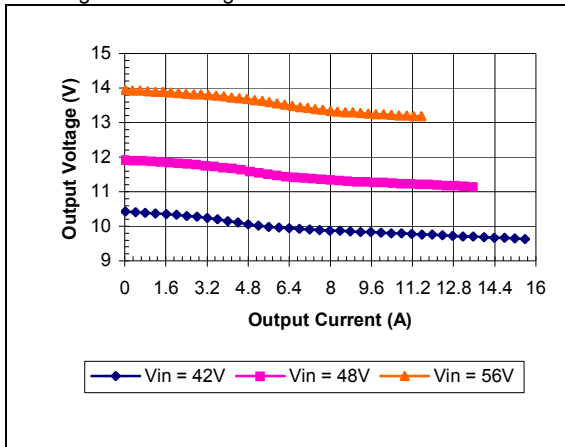

iEB48013A120V-000 Typical Output Voltage vs. Load Current at Ta = 25 degrees

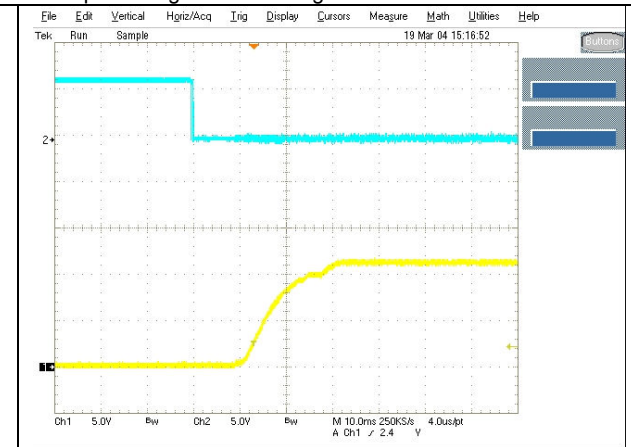

iEB48013A120V-001 Typical startup characteristic from on/off at full load, 10mS/div. Upper trace - on/off signal 5V/div, lower trace – output voltage 5V/div.

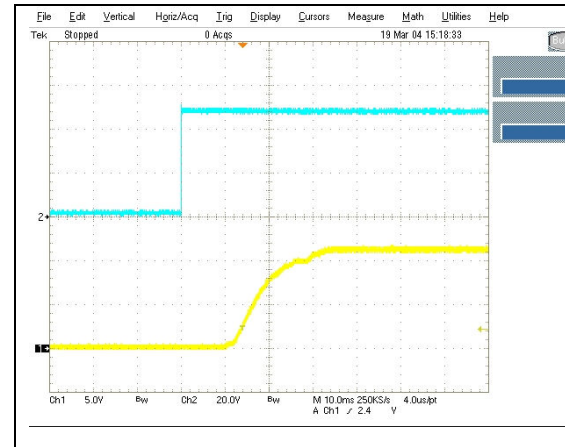

iEB48013A120V-000 Typical startup characteristic from input voltage application at full load, 10mS/div. Upper trace - input voltage 20V/div, lower trace – output voltage 5V/div

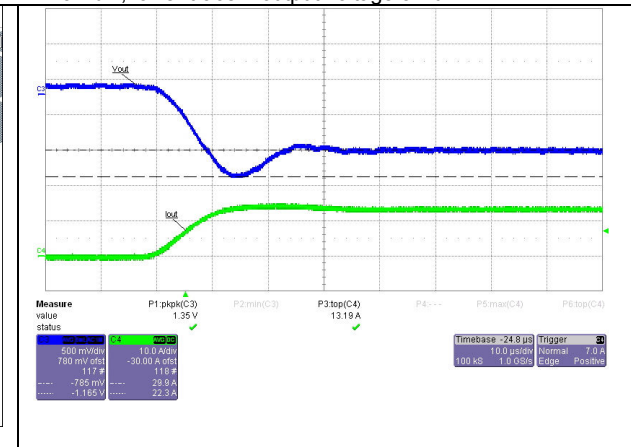

iEB48013A120V-000 Typical transient response 10uS/div. Output voltage response to load step from 0% to 100% of full load with output current slew rate of 1A/uS, Upper trace – output voltage 500mV/div.

**Electrical Characteristics (continued):**  
**iEB48013A120V-000 through -005: 12V, 13.5A Output**

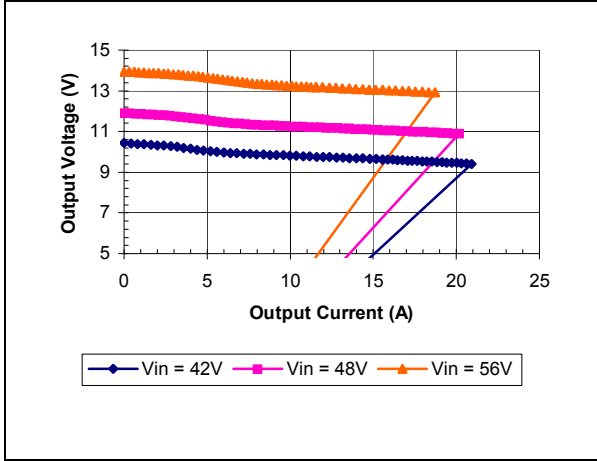

iEB48013A120V-005 Typical Output Current Limit Characteristics vs. Input Voltage at Ta=25 degrees.

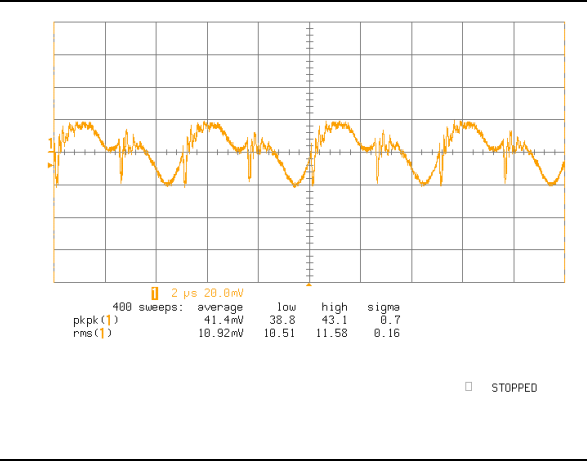

iEB48013A120V-000 Typical Output Ripple at nominal Input voltage and full load at Ta=25 degrees

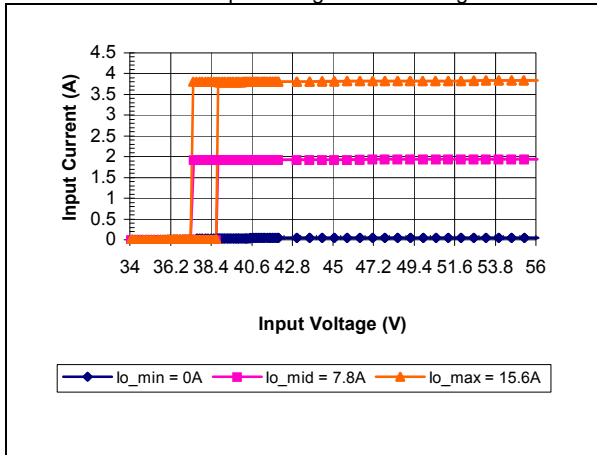

iEB48013A120V-000 Typical Input Current vs. Input Voltage Characteristics

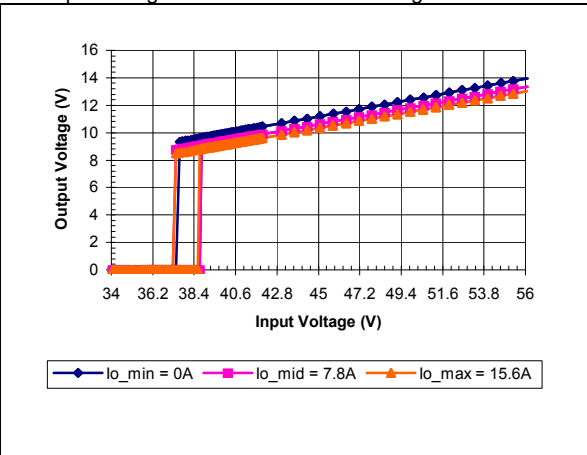

iEB48013A120V-000 Typical Output Voltage vs. Input Voltage Characteristics



# Data Sheet: FReta iEB Series –Single Output Eighth Brick Bus Converter

## Thermal Performance: iEB48013A120V-000 through -005: 12V, 13.5A Output

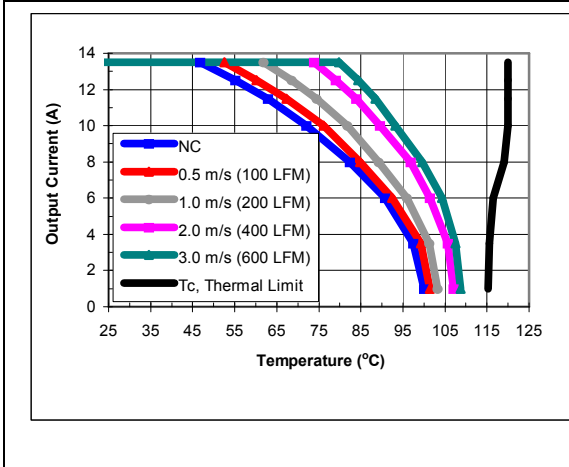

iEB48013A120V-000 maximum output current vs. ambient temperature at nominal input voltage for airflow rates natural convection (60lfm) to 600lfm with airflow from pin 3 to pin 1.

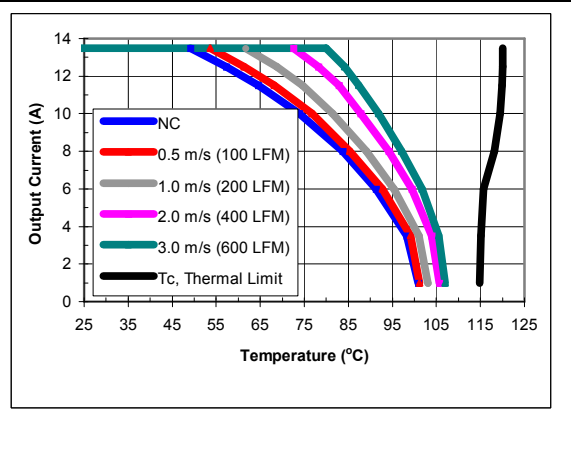

iEB48013A120V-000 maximum output current vs. ambient temperature at nominal input voltage for airflow rates natural convection (60lfm) to 600lfm with airflow from output to input.

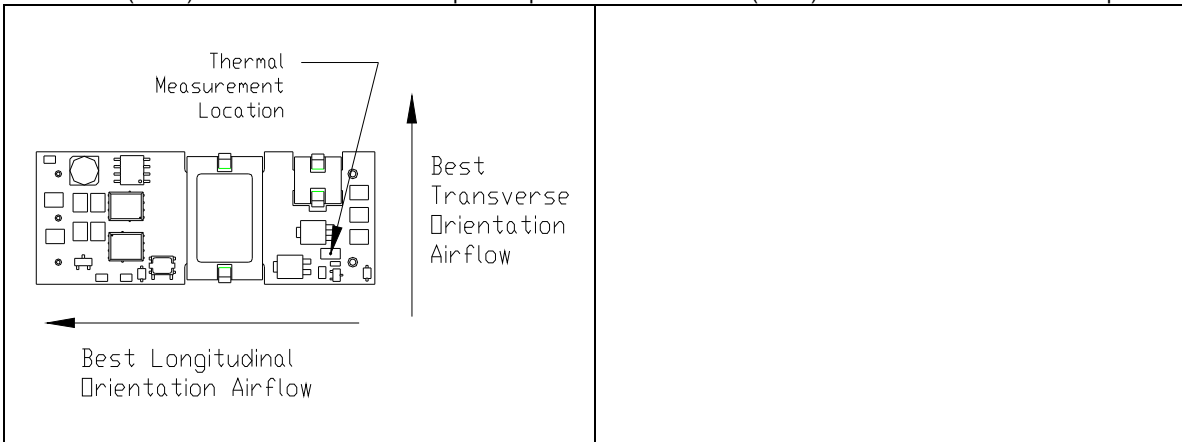

iEB48013A120V-000 thermal measurement location – top view

Both the thermal curves provided and the example given above are based upon measurements made in TDK Innoveta's experimental test setup that is described in the Thermal Management section. Due to the large number of variables in system design, TDK Innoveta recommends that the user verify the module's thermal performance in the end application. The critical component should be thermo coupled and monitored, and should not exceed the temperature limit specified in the derating curve above. It is critical that the thermocouple be mounted in a manner that gives direct thermal contact or significant measurement errors may result. TDK Innoveta can provide modules with a thermocouple pre-mounted to the critical component for system verification tests.

## Thermal Management:

An important part of the overall system design process is thermal management; thermal design must be considered at all levels to ensure good reliability and lifetime of the final system. Superior thermal design and the ability to operate in severe application environments are key elements of a robust, reliable power module.

A finite amount of heat must be dissipated from the power module to the surrounding environment. This heat is transferred by the three modes of heat transfer: convection, conduction and radiation. While all three modes of heat transfer are present in every application, convection is the dominant mode of heat transfer in most applications. However, to ensure adequate cooling and proper operation, all three modes should be considered in a final system configuration.

The open frame design of the power module provides an air path to individual components. This air path improves convection cooling to the surrounding environment, which reduces areas of heat concentration and resulting hot spots.

**Test Setup:** The thermal performance data of the power module is based upon measurements obtained from a wind tunnel test with the setup shown in the wind tunnel figure. This thermal test setup replicates the typical thermal environments encountered in most modern electronic systems with distributed power architectures. The electronic equipment in networking, telecom, wireless, and advanced computer systems operates in similar environments and utilizes vertically mounted PCBs or circuit cards in cabinet racks.

The power module, as shown in the figure, is mounted on a printed circuit board (PCB) and is vertically oriented within the wind tunnel. The cross section of the airflow passage is rectangular. The spacing between the top of the module and a parallel facing PCB is kept at a constant (0.5 in). The power module's orientation with respect

to the airflow direction can have a significant impact on the module's thermal performance.

**Thermal Derating:** For proper application of the power module in a given thermal environment, output current derating curves are provided as a design

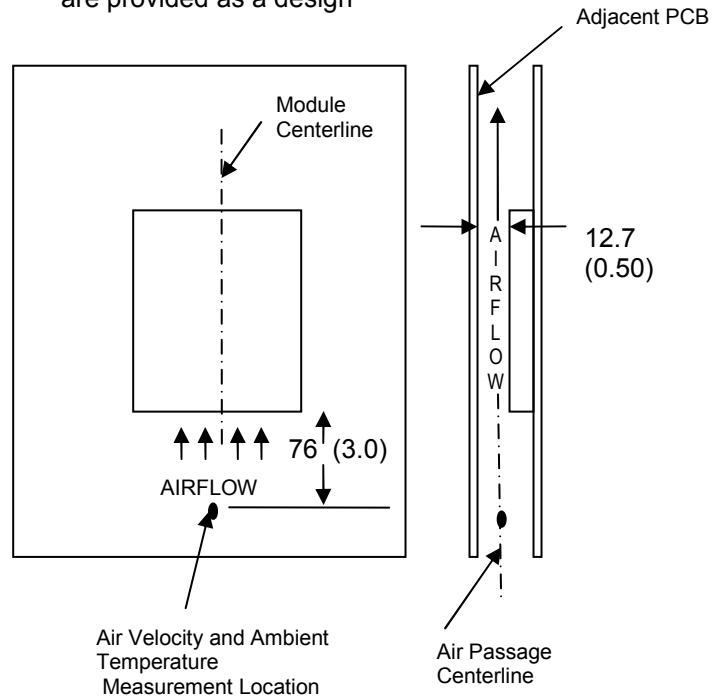

**Wind Tunnel Test Setup Figure** Dimensions are in millimeters and (inches).

guideline on the Thermal Performance section for the power module of interest. The module temperature should be measured in the final system configuration to ensure proper thermal management of the power module. For thermal performance verification, the module temperature should be measured at the component indicated in the thermal measurement location figure on the thermal performance page for the power module of interest. In all conditions, the power module should be operated below the maximum operating temperature shown on the derating curve. For improved design margins and enhanced system reliability, the power module may be operated at temperatures below the maximum rated operating temperature.

## Data Sheet: FReta iEB Series –Single Output Eighth Brick Bus Converter

Heat transfer by convection can be enhanced by increasing the airflow rate that the power module experiences. The maximum output current of the power module is a function of ambient temperature ( $T_{AMB}$ ) and airflow rate as shown in the thermal performance figures on the thermal performance page for the power module of interest. The curves in the figures are shown for natural convection through 2 m/s (400 ft/min). The data for the natural convection condition has been collected at 0.3 m/s (60 ft/min) of airflow, which is the typical airflow generated by other heat dissipating components in many of the systems that these types of modules are used in. In the final system configurations, the airflow rate for the natural convection condition can vary due to temperature gradients from other heat dissipating components.

### Operating Information:

**Over-Current Protection:** The power modules have current limit protection to protect the module during output overload and short circuit conditions. During overload conditions, the power modules may protect themselves by entering a hiccup current limit mode. The modules will operate normally once the output current returns to the specified operating range

**Thermal Protection:** When the power modules exceed the maximum operating temperature, the modules may turn off to safeguard the power unit against thermal damage. The module will auto restart as the unit is cooled below the over temperature threshold.

**Remote On/Off:** - The power modules have an internal remote on/off circuit. The user must supply an open-collector or compatible switch between the  $V_{in(-)}$  pin and the on/off pin. The maximum voltage generated by the power module at the on/off terminal is 15V. The maximum allowable leakage current of the switch is 50uA. The switch must be capable of maintaining a low signal  $V_{on/off} < 1.2V$  while sinking 1mA.

The standard on/off logic is positive logic. The power module will turn on if terminal 2 is left open and will be off if terminal 2 is connected to terminal 3. If the positive logic circuit is not being used, terminal 2 should be left open.

An optional negative logic is available. The power module will turn on if terminal 2 is connected to terminal 3, and it will be off if terminal 2 is left open. If the negative logic feature is not being used, terminal 2 should be shorted to terminal 3.

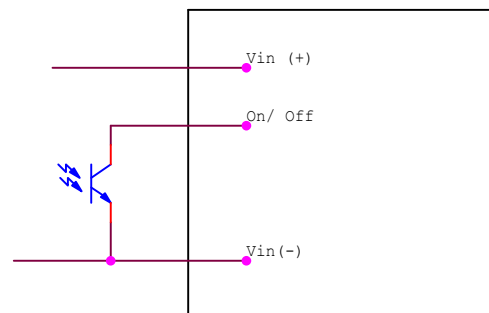

**On/Off Circuit for positive or negative logic**

## Data Sheet: FReta iEB Series –Single Output Eighth Brick Bus Converter

**EMC Considerations:** TDK Innoveta power modules are designed for use in a wide variety of systems and applications. For assistance with designing for EMC compliance, please contact TDK Innoveta technical support.

**Input Impedance:**

The source impedance of the power feeding the DC/DC converter module will interact with the DC/DC converter. To minimize the interaction, a 33-100uF input electrolytic capacitor should be present if the source inductance is greater than 2uH.

**Reliability:**

The power modules are designed using TDK Innoveta's stringent design guidelines for component derating, product qualification, and design reviews. Early failures are screened out by both burn-in and an

automated final test. The MTBF is calculated to be greater than 3.9M hours at full output power and  $T_a = 40^{\circ}\text{C}$  using the Telcordia SR-332 calculation method.

Improper handling or cleaning processes can adversely affect the appearance, testability, and reliability of the power modules. Contact TDK Innoveta technical support for guidance regarding proper handling, cleaning, and soldering of TDK Innoveta's power modules.

**Quality:**

TDK Innoveta's product development process incorporates advanced quality planning tools such as FMEA and Cpk analysis to ensure designs are robust and reliable. All products are assembled at ISO certified assembly plants.

**Input/Output Ripple and Noise Measurements:**

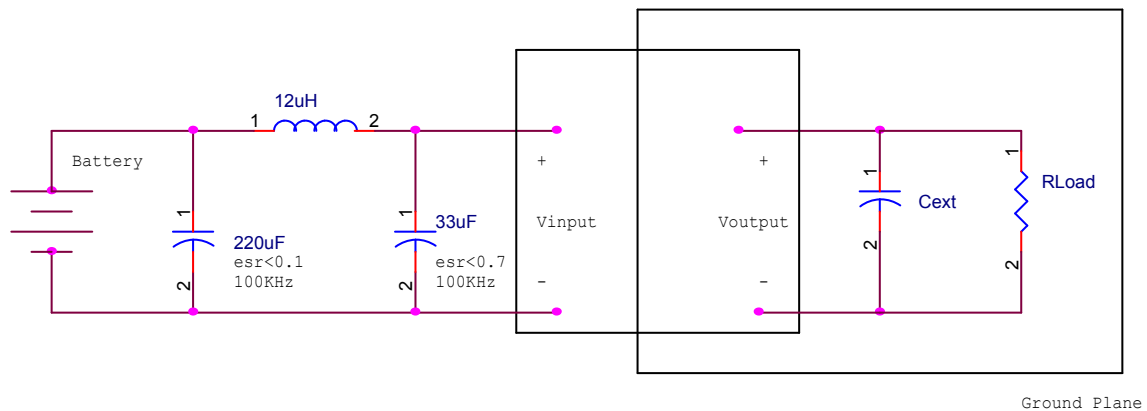

The input reflected ripple is measured with a current probe and oscilloscope. The ripple current is the current through the 12uH inductor.

The output ripple measurement is made approximately 9 cm (3.5 in.) from the power module using an oscilloscope and BNC socket. The capacitor Cext is located about 5 cm (2 in.) from the power module; its value varies from code to code and is found on the electrical data page for the power module of interest under the ripple & noise voltage specification in the Notes & Conditions column.



## Data Sheet: FReta iEB Series –Single Output Eighth Brick Bus Converter

### Safety Considerations:

Check with TDK Innoveta for the current status of safety approval on the iEB product family.

For safety agency approval of the system in which the DC-DC power module is installed, the power module must be installed in compliance with the creepage and clearance requirements of the safety agency. The isolation is basic insulation. For applications requiring basic insulation, care must be taken to maintain minimum creepage and clearance distances when routing traces near the power module.

As part of the production process, the power modules are hi-pot tested from primary and secondary at a test voltage of 1500Vdc.

To preserve maximum flexibility, the power modules are not internally fused. An external input line normal blow fuse with a maximum value of 10A is required by safety agencies. A lower value fuse can be selected based upon the maximum dc input current and maximum inrush energy of the power module.

When the supply to the DC-DC converter is less than 60Vdc, the power module meets all of the requirements for SELV. If the input voltage is a hazardous voltage that exceeds 60Vdc, the output can be considered SELV only if the following conditions are met:

- 1) The input source is isolated from the ac mains by reinforced insulation.
- 2) The input terminal pins are not accessible.
- 3) One pole of the input and one pole of the output are grounded or both are kept floating.
- 4) Single fault testing is performed on the end system to ensure that under a single fault, hazardous voltages do not appear at the module output.

### Warranty:

TDK Innoveta's comprehensive line of power solutions includes efficient, high-density DC-DC converters. TDK Innoveta offers a three-year limited warranty. Complete warranty information is listed on our web site or is available upon request from TDK Innoveta.



3320 Matrix Drive Suite 100  
Richardson, Texas 75082

Phone (877) 498-0099 Toll Free  
(469) 916-4747

Fax (877) 498-0143 Toll Free  
(214) 239-3101

[support@tdkinnoveta.com](mailto:support@tdkinnoveta.com)  
<http://www.tdkinnoveta.com/>

Information furnished by TDK Innoveta is believed to be accurate and reliable. However, TDK Innoveta assumes no responsibility for its use, nor for any infringement of patents or other rights of third parties, which may result from its use. No license is granted by implication or otherwise under any patent or patent rights of TDK Innoveta. TDK Innoveta components are not designed to be used in applications, such as life support systems, wherein failure or malfunction could result in injury or death. All sales are subject to TDK Innoveta's Terms and Conditions of Sale, which are available upon request.

Specifications are subject to change without notice.



is a trademark or registered trademark of TDK Corporation.